

PUNZONES FERRY PARA PLEGADORA

TIPO COLLY

1411/90° - R1,4
1412/85° - R0,6

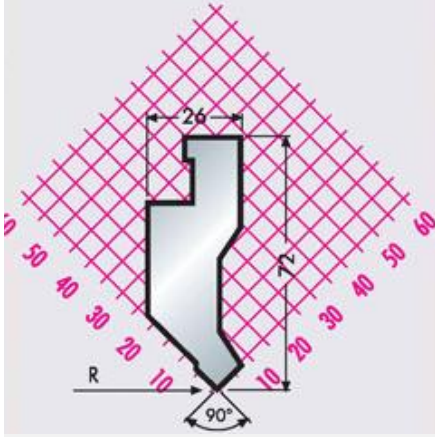

1715/90° - R1,4
1716/85° - R0,6

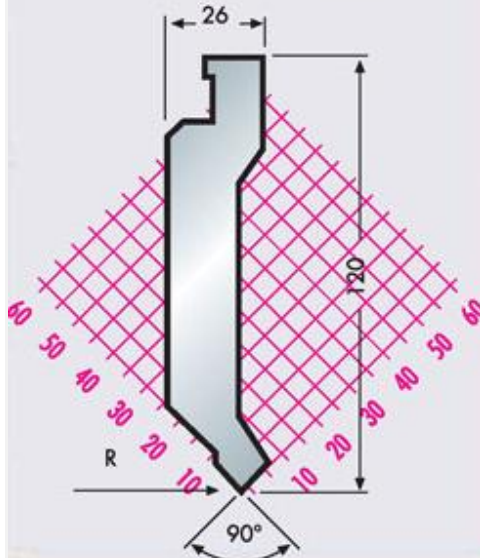

1515/90° - R1,4
1516/85° - R0,6

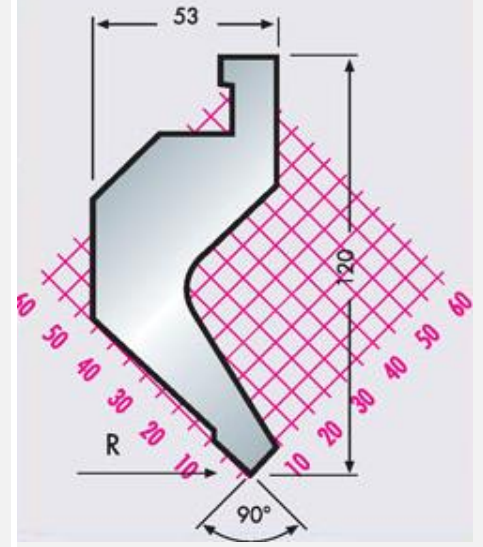

1401/90°
1402/85°

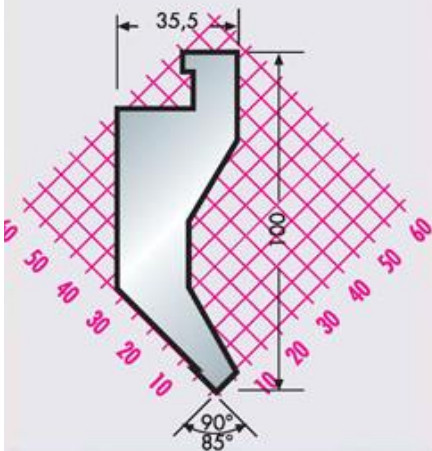

1420/85°

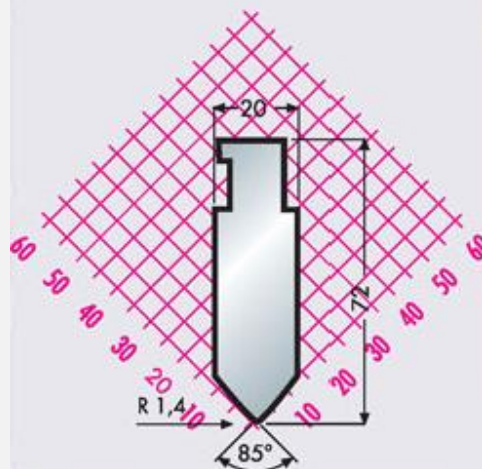

1806/85°

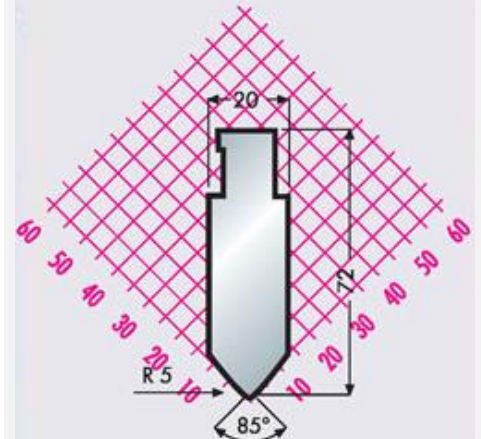

* 1703/80°

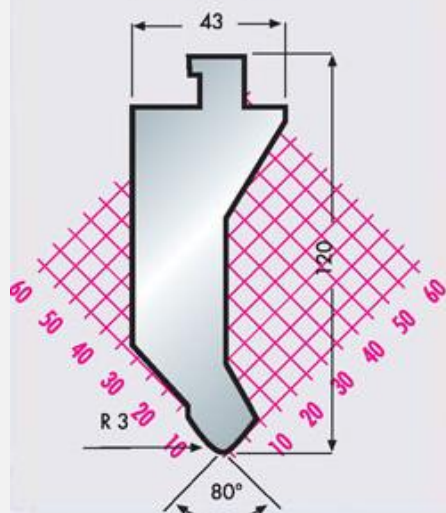

* 1758/80°

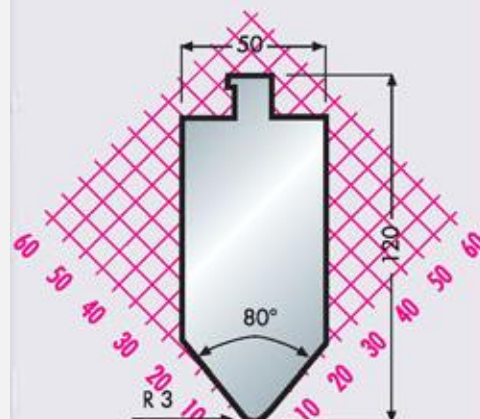

* 1705/80°

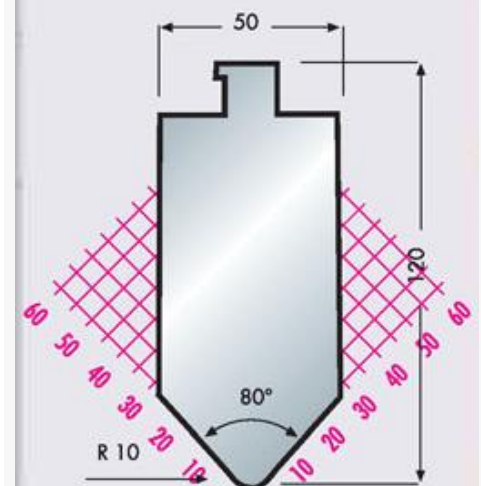

PUNZONES FERRY PARA PLEGADORA

TIPO COLLY

1418/24°

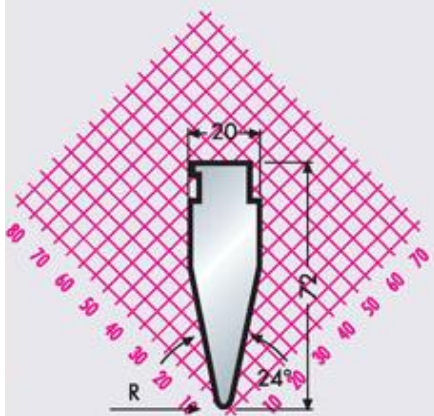

1526/24°

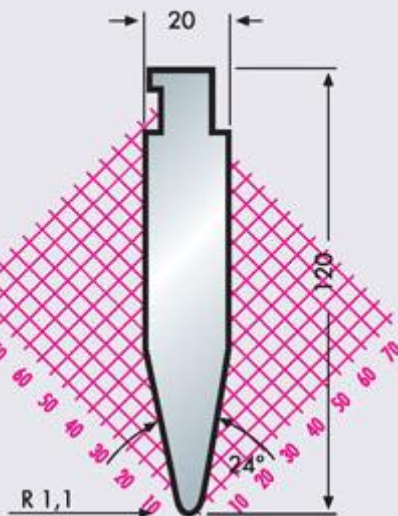

*** 1528/24°**

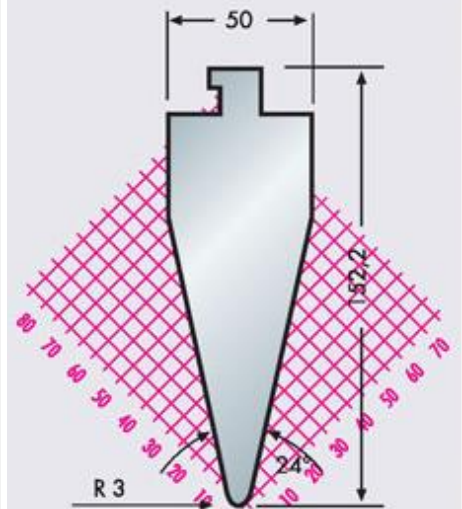

1696/50°

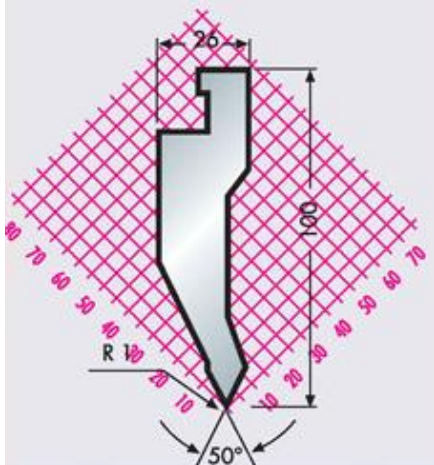

1697/50°

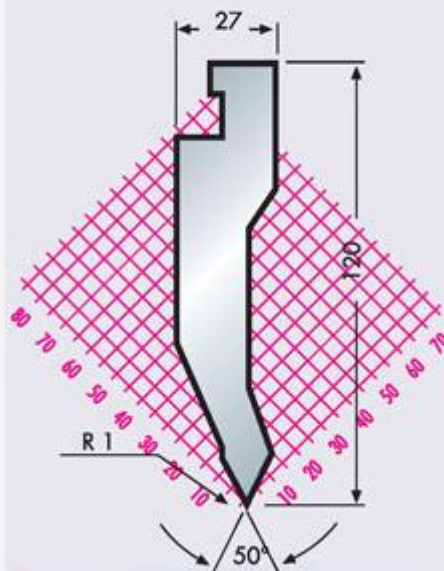

1705/50°

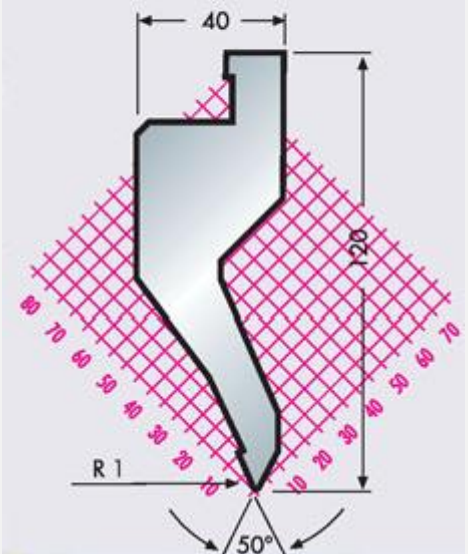

1419 Plano

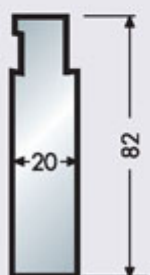

*** 1706 Plano**

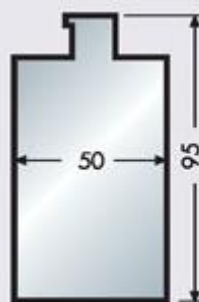

40.10.244

L=415 mm
L=835 mm

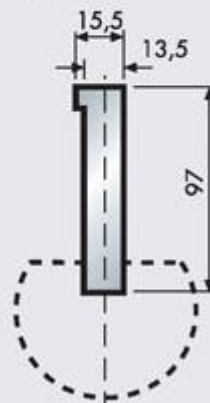

40.09

17

100 T/m

L=415 mm
L=835 mm

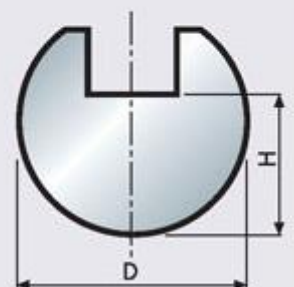

D	20	25	30	35	40	50	60	80	100
H	12	17	20	22	24	29	34	44	70

PUNZONES FERRY PARA PLEGADORA

TIPO COLLY

* 1517/90° - R1,4
1518/80° - R3

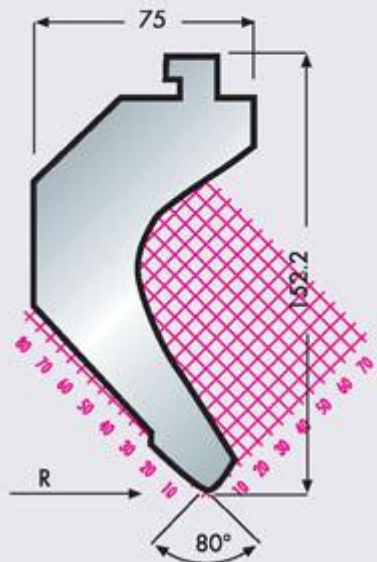

* 1544/85°

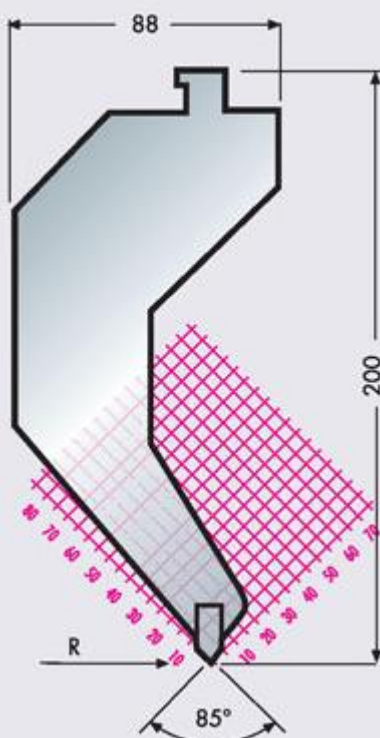

1422/85°

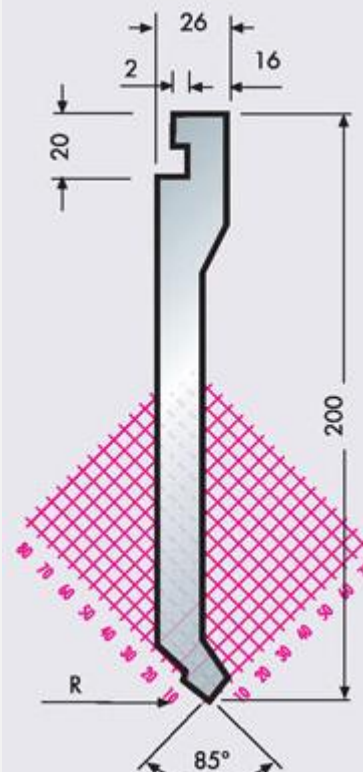

INTERMEDIARIOS-COLLY

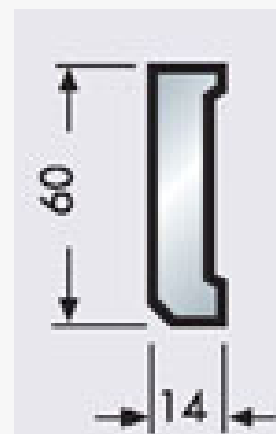
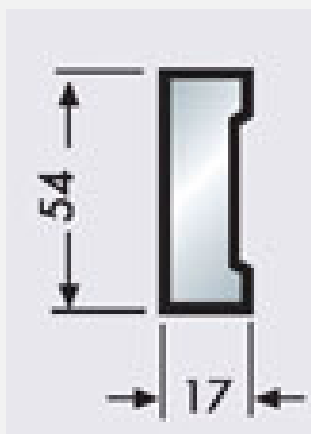
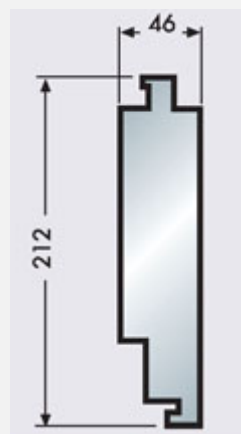
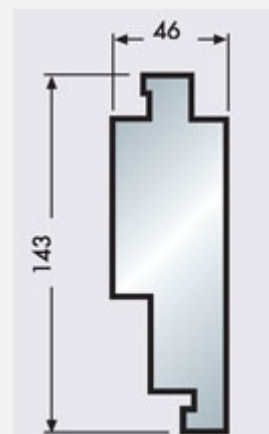
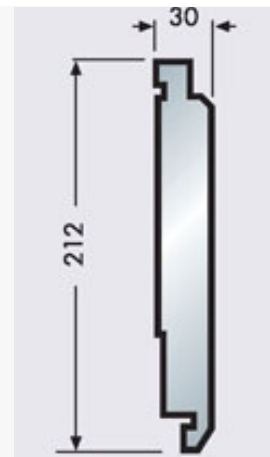
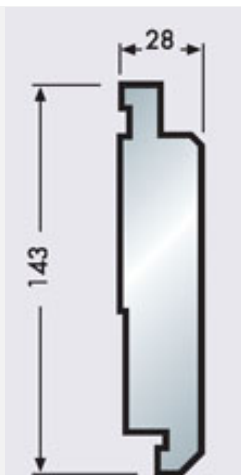
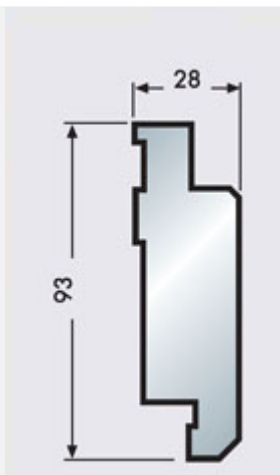

MATRICES FERRY PARA PLEGADORA

TIPO COLLY

2447/90°

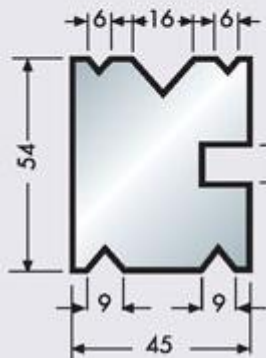

M01

2355/85°

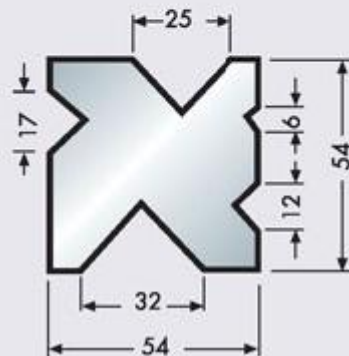

1318

1319

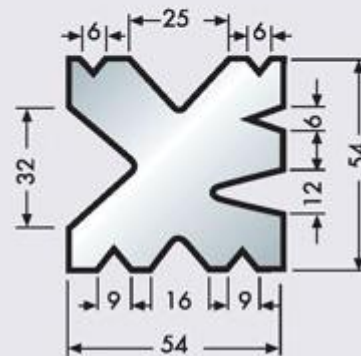

10.02.258

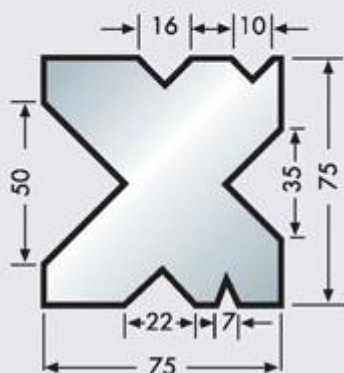

20.10.626

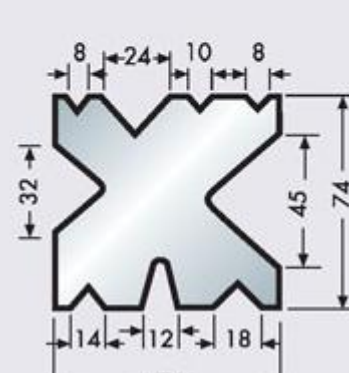

1518/85°

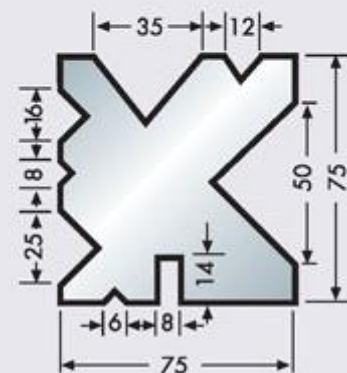

20.10.627

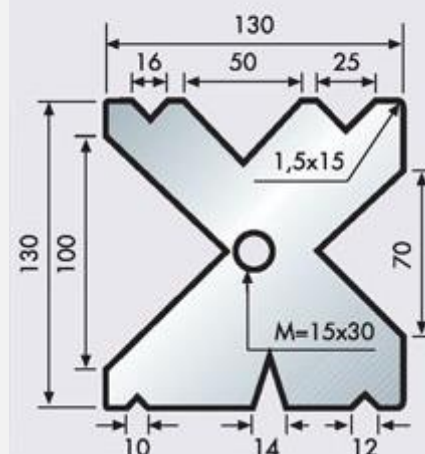
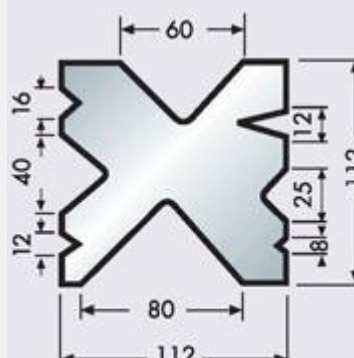
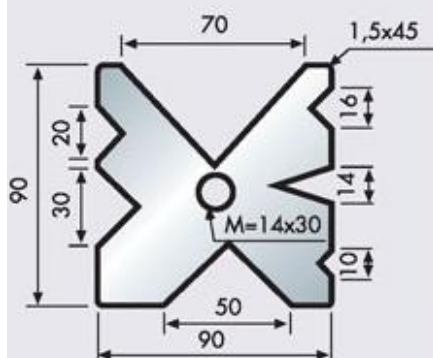

MATRICES FERRY PARA PLEGADORA

TIPO COLLY

2414/85°

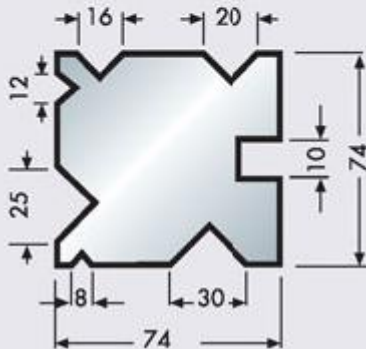

2413/90°

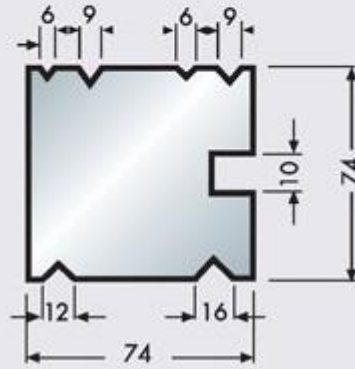

1519

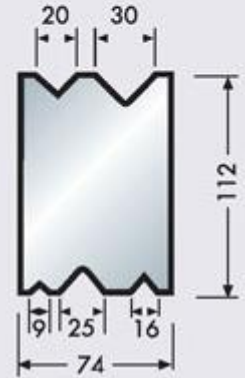

1359/85°

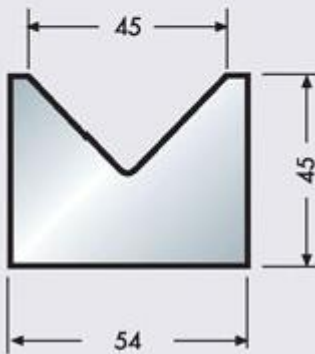

1361/85°

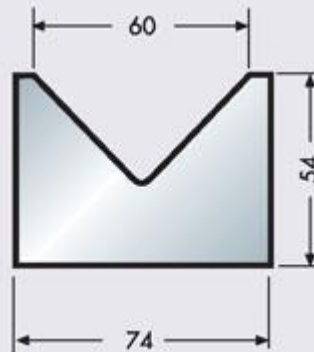

1520

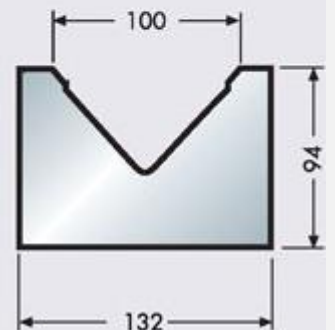

1320

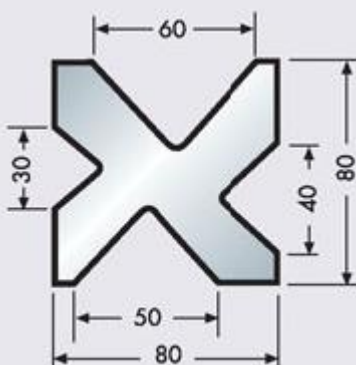

1521

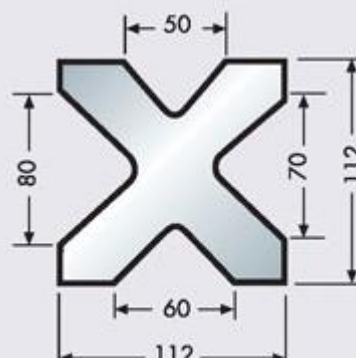

1707

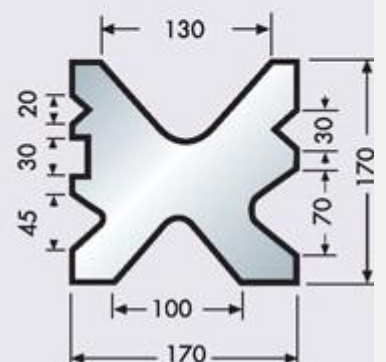

MATRICES FERRY PARA PLEGADORA

TIPO COLLY

1415/85°

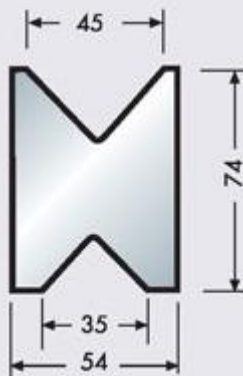

1417/85°

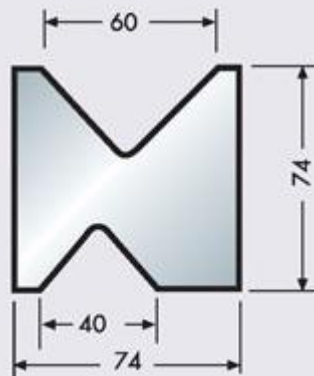

1814/80°

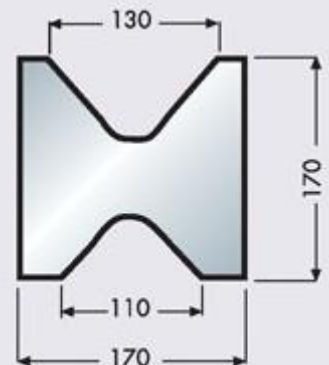

767/50°

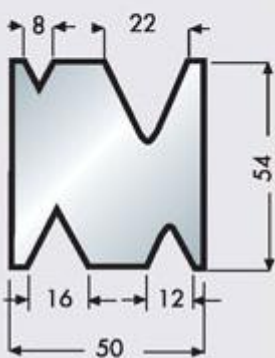

768/50°



770/50°



769/50°

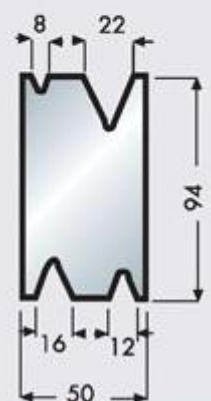

771/50°

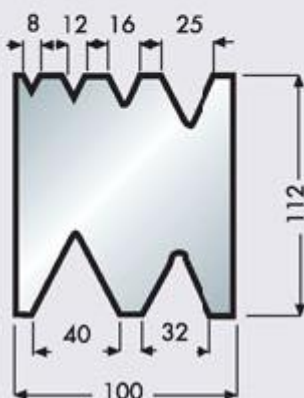

1759/80°

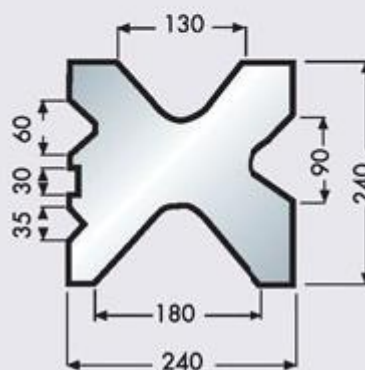

2479/24° V6/8

