

PUNZONES FERRY PARA PLEGADORA

TIPO SPEED-TRUMPF

SPE 10.61/28°



SPE 10.62/86°

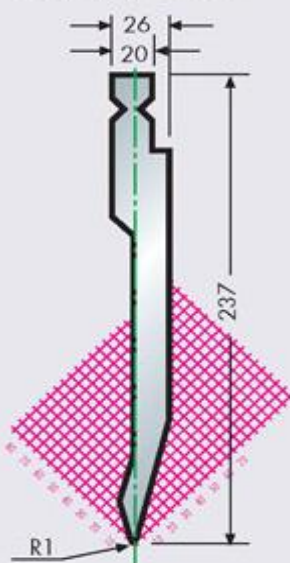

SPE 10.63/60°

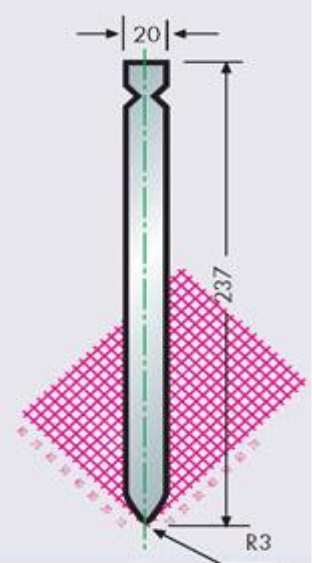

SPE 10.64/28°

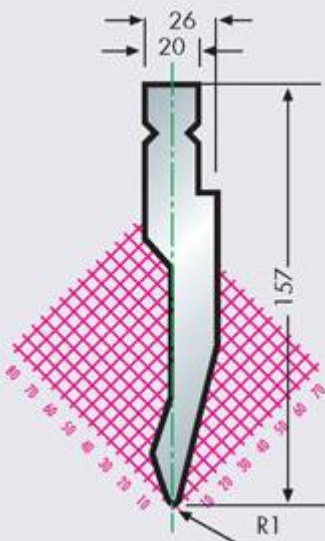

SPE 10.65/86°

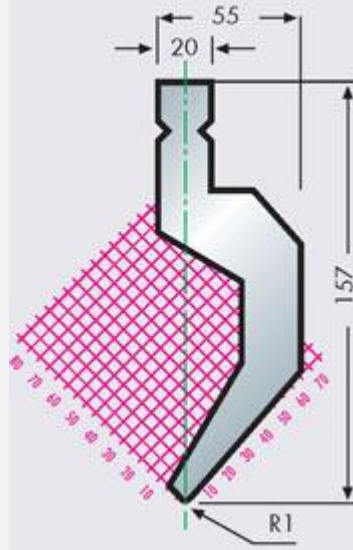

SPE 40.01

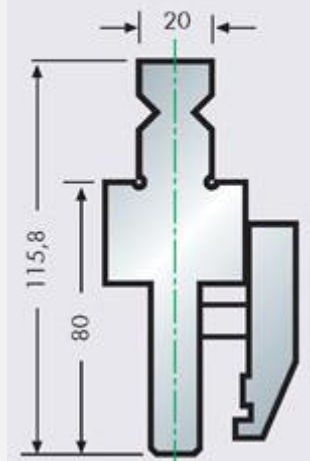

SPE 10.80



40.02

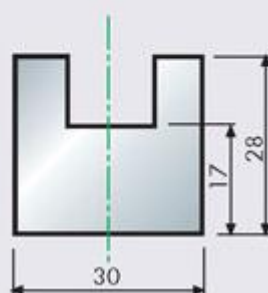

40.09

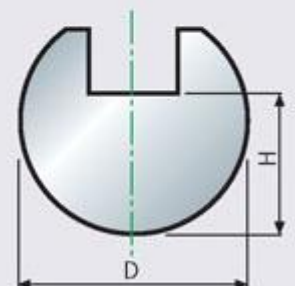

L=415 mm
835 mm

D	20	25	30	35	40	50	60	80	100
H	12	17	20	22	24	29	34	44	70

MATRICES FERRY PARA PLEGADORA

TIPO SPEED-TRUMPF

SPE V8/30°

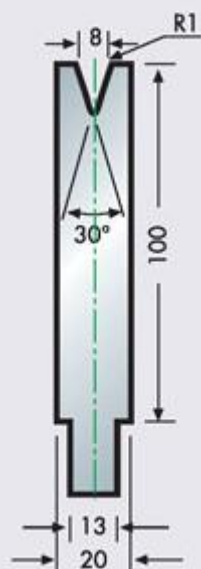

SPE V10/30°



SPE V12/30°

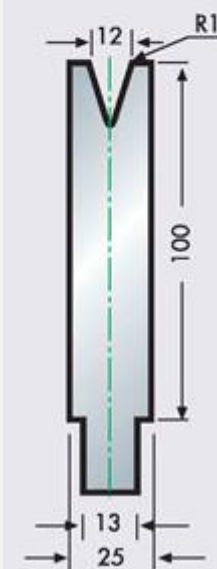

SPE V16/30°

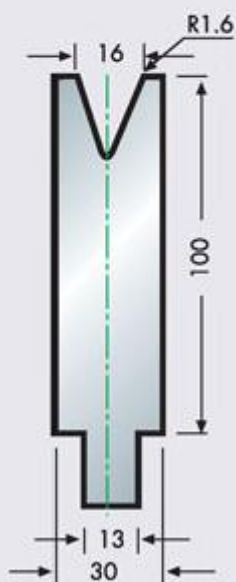

SPE V20/30°

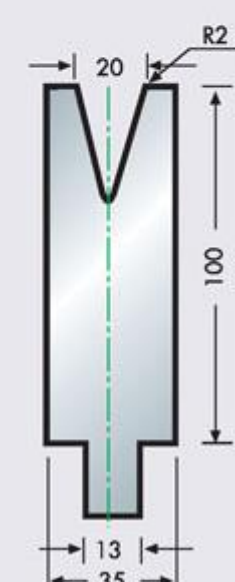

SPE V24/30°

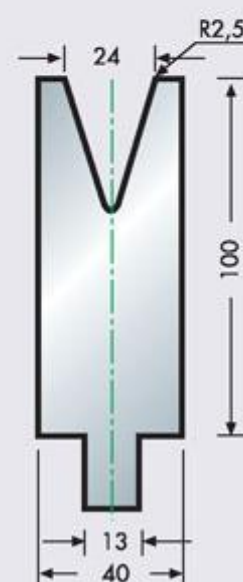

MATRICES FERRY PARA PLEGADORA

TIPO SPEED-TRUMPF

SPE V32/30°

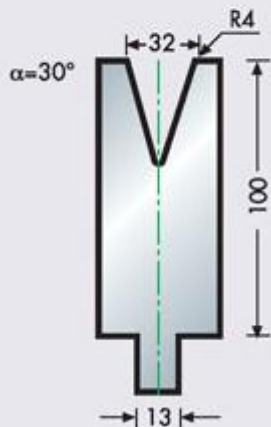

SPE V40/80°

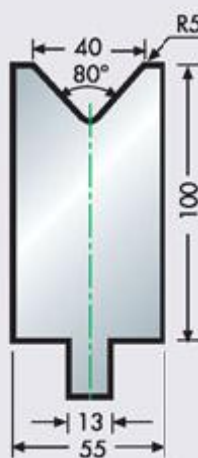

SPE V50/80°

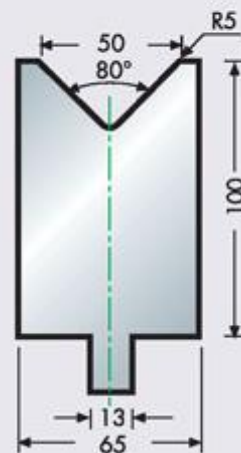

SPE 40.40

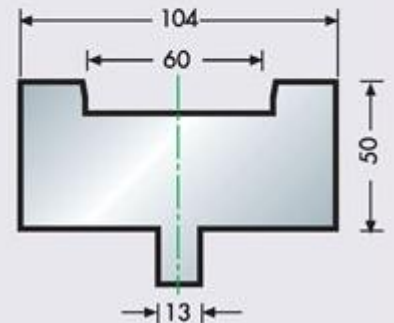

SPE 30.01- P8

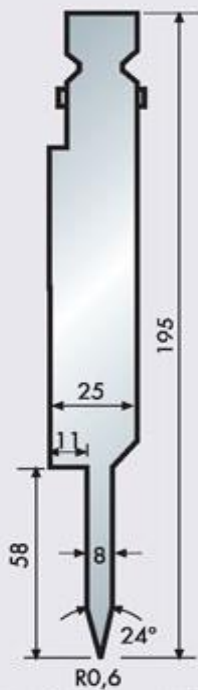

SPE 30.01- M8

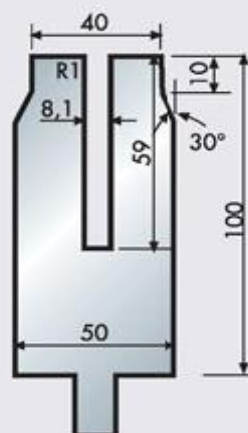

SPE 30.01- P10

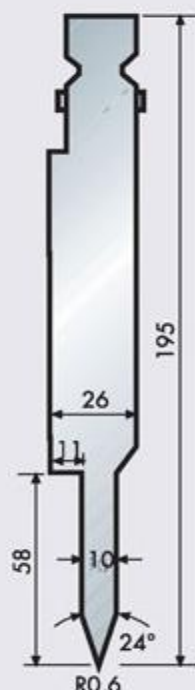

SPE 30.01- M10

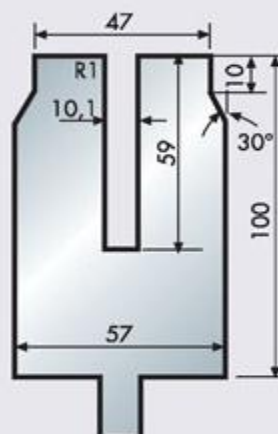

SPE 30.01- P12

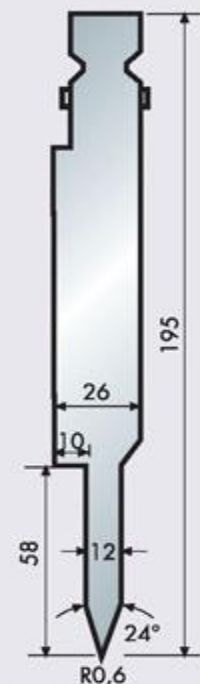

SPE 30.01- M12

